

KOBELCO

Performance  Design

SK210_{LC} SK210_{NLC}

- Bucket capacity:
0.45 – 0.80 m³
- Engine power:
124 kW / 2,000 min⁻¹
- Operating weight:
21,900 – 24,500 kg



Complies with the EU Stage V
exhaust emission regulation

We Save You Fuel
Achieving a Low-Carbon Society



Performance Design

SK210LC/SK210NLC of KOBELCO has realised a completely new value by harmonising PERFORMANCE – greater efficiency and productivity with an increased power and speed and DESIGN – operator-based operability and comfort, refusing to accept any compromises. In pursuit of unique and matchless machines which are unforgettable once you use them, KOBELCO will continue to rise to meet every challenge.



THE ULTIMATE IN SIMPLE AND ELEGANT DESIGN

Our pursuit of functional beauty and aesthetic sense produced a new interior design.

Jog dial

This jog dial integrates multiple functions to realise simple operations. Even with gloved hands, the operator can set various machine conditions without stress.

LED backlights

The switches and dials have LED backlights – they provide a bright, clear view in the dark and set a luxurious mood.







UNFORGETTABLE COMFORT

1 Air suspension seat with heating

A GRAMMER* seat is installed as standard equipment, which achieves excellent shock absorption and superior ride comfort.

*GRAMMER is trademark of GRAMMER AG, registered in Germany and other countries.

2 Air-conditioner

Air is blown against the operator's waist and the back of their head, offering more comfortable operation.

3 Lever angles allow for comfortable operations

The operator can move the levers horizontally without twisting their wrist, which reduces the fatigue caused by the operations.



New Hydraulic Control

Our newly upgraded hydraulic control system responds to shorter lever strokes than current models, delivering swifter, more precise movement and improved lever operability.

4 LED door light

The LED interior light automatically turns on when the door is opened or when the ignition is set to OFF. This ensures easy entry and exit at nighttime.

5 Parallel wipers secure a wide field of view



KOBELCO

ECO

04:33



SETTING MENU



PICTURE OF
CAMERA



CLOCK
SETTING



SCREEN
BRIGHTNESS



MAINTENANCE



CONSUMPTION



LANGUAGE
SELECTION



PRESSURE
RELEASE



A WIDER VIEW BRINGS A WIDER RANGE OF USE

10-inch colour monitor (the largest in the industry)

The easy-to-operate menu screen facilitates reading of important information. Images from the built-in cameras can be checked on the large screen, which helps secure safety. In addition, each icon has become easy to recognise. A password is required when starting the engine for greater security.



The right camera and rear view camera (right side view mode)

The right camera and rear view camera (straight view mode)

The right camera and rear view camera (right side view mode)

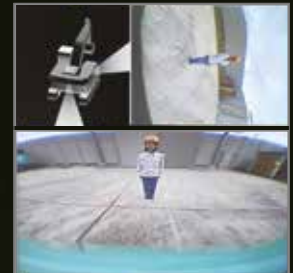

The right camera and rear view camera (straight view mode)



The bird's-eye view



The eagle eye view

Right camera and rear view camera

Images from the right camera and rear view camera are displayed together on the large colour monitor. The right camera view can be selected between the straight view mode and right side view mode.

In addition, the bird's-eye view mode and the eagle eye mode can also be selected.

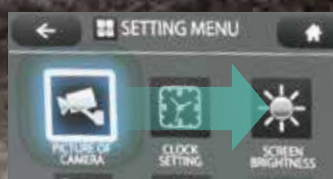

Screen display linked with the jog dial operation

The jog dial can be operated as desired without causing stress. Turn the jog dial to the right or left to select an item and press the dial to confirm the selection.





Independent Travel

Selecting Independent Travel dedicates one hydraulic pump to travel and one to the attachment on a continuous basis, allowing for a smooth and constant movement speed even while swinging or using the boom or attachment. With Independent Travel, safely carrying a large pipe across a job site is a breeze.

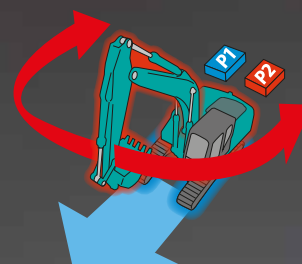

EXPERIENCING A COMPETENT PERFORMANCE

Excellent machine stability, plus a EU Stage V compliant engine

Equipped with the new EU Stage V compliant engine, the SK210LC/SK210NLC feature outstanding stability thanks to an innovative new shape for conventional excavator, as well as a larger counterweight.

Model: HINO J05EVA-KSSA

Engine output

124 kW / 2,000 min⁻¹



»» Max. bucket digging force (Arm 2.94 m)

Normal: **143** kN

With Power Boost: **157** kN

Lift capacity

11,820 kg

(Reach: 4.50 m Boom: 5.65 m Arm: 2.94 m Bucket: Without
Counterweight: 4,900 kg Shoe: 600 mm <Heavy Lift>)



GREATER MULTI-FUNCTION CAPABILITIES

Attachment mode

The flow rate and working pressure modes of the bucket, breaker, nibbler, and rotating grapple are set before delivery, which allows you to start operating immediately. Mode settings for other attachments, such as the tilt rotator, can easily be added or changed.



Adjustment for hydraulic flow

Divide ratio of hydraulic flow can be adjusted by service factory for custom usage.



EASY MAINTENANCE



Standard OPG Level II top guard

The standard OPG Level II top guard can be tilted open for easy window cleaning. Meets standard FOPS and OPG Level II top guard requirements. (ISO 10262:1998)



Two-stage air filter



Urea tank

Urea filter cap is placed on the step for easy access.



Left side (radiator and cooling system elements)

Laid out for easy access to radiator and cooling system.



Right side



Fuel filter/Pre-filter



Engine oil filter

DURABILITY YOU CAN TRUST

Enhanced body rigidity for 20-ton class machines

The SK210LC and SK210NLC machines are widely used in mid-scale construction projects and harsh worksites. The components have been reviewed and improvements have been made to their durability to ensure stable performance in such environments.



Panels and supports
The right and left side panels and rear supports have been thicker to enhance body rigidity.



Bucket cylinder rod pin
The increased diameter of the bucket cylinder rod pin contributes to enhanced durability for various types of attachments.

CONVENIENT AND SENSIBLE EQUIPMENT



Engine start password

A password is required when starting the engine for greater security. The initial password must be set at our workshop.



Wiper adjustment function

In addition to the intermittent wiper mode and continuous wiper mode, the one-time wiper mode was added.



Parallel wipers/Sun screen



Console mount

The console-integrated seat allows for comfortable operation.



DAB+ radio (FM/AM & AUX & USB & Bluetooth® & hands-free telephone)



USB port/12 V power supply



Smartphone holder

You can use the holder with your smartphone connected to the USB port.



KOMEXS KOBELCO MONITORING EXCAVATOR SYSTEM



Customer



KOBELCO office



KOBELCO service personnel



Remote Monitoring for Peace of Mind

KOMEXS (Kobelco Monitoring Excavator System) uses satellite communication and internet to relay data, and therefore can be deployed in areas where other forms of communication are difficult. When a hydraulic excavator is fitted with this system, data on the machine's operation, such as operating hours, location, fuel consumption, and maintenance status can be obtained remotely.

Direct Access to Operational Status

Location Data

Accurate location data can be obtained even from sites where communications are difficult.

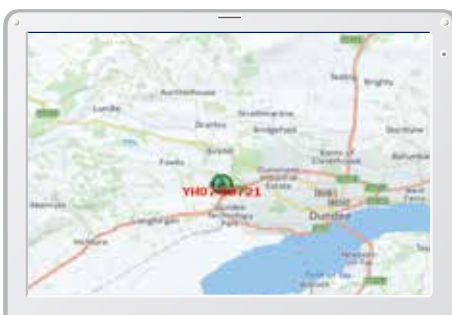

Latest location

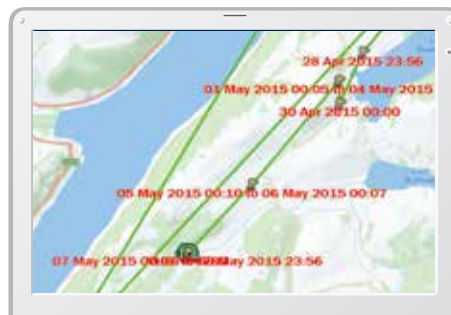

Location records

Type of Operation		Working Hrs	Ratio
Total Working Hrs		169 Hrs	100 %
Digging Hrs		72.2 Hrs	43 %
Traveling Hrs		18.3 Hrs	11 %
Idle Hrs		15.9 Hrs	9 %
Opt Alt Hrs		62.5 Hrs	37 %
Crane Mode Hrs		0 Hrs	0 %

Work data

Operating Hours

- A comparison of operating times of machines at multiple locations shows which locations are busier and more profitable.
- Operating hours on site can be accurately recorded, for running time calculations needed for rental machines, etc.

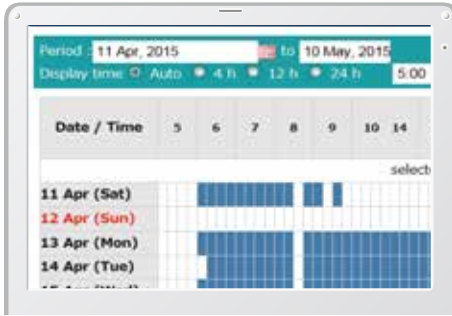

Daily report

Fuel Consumption Data

Data on fuel consumption and idling times can be used to indicate improvements in fuel consumption.

Work mode	Working Hrs	Total Fuel Consumption
H mode	2:06	24.5 L
S mode	0:00	0.0 L
E mode	169:19	1489.7 L
TOTAL	171:25	1514.2 L

Fuel consumption

Graph of Work Content

The graph shows how working hours are divided among different operating categories, including digging, idling, travelling and optional operations.

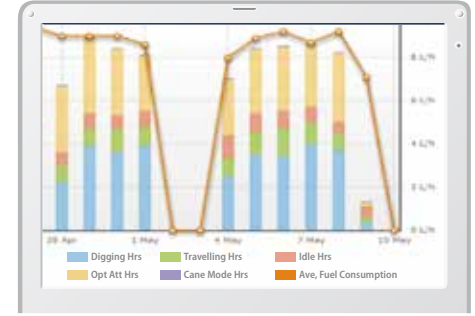

Work status

Maintenance Data and Warning Alerts

Machine Maintenance Data

- Provides maintenance status of separate machines operating at multiple sites.
- Maintenance data is also relayed to KOBELCO service personnel, for more efficient planning of periodic servicing.

Model	Serial No.	Hour Meter	Engine Oil
SK135RCL-3/SK140SRL	YH07-09221	734 Hr	434
SK135RCL-3/SK140SRL	YH07-09289	73 Hr	429
SK210LC-9	YQ13-10454	960 Hr	58
SK210LC-9	YQ13-10481	549 Hr	498
SK75SR-	YT08-20374		

Maintenance

Warning Alerts

This system warns an alert if an anomaly is sensed, preventing damage that could result in machine downtime.

Alarm Information Can Be Received through E-mail

Alarm information or maintenance notice can be received through E-mail, using a computer or cell phone.



Alarm messages can be received on mobile device.

Daily/Monthly Reports

Operational data downloaded onto a computer helps in formulating daily and monthly reports.

Security System

Engine Start Alarm

The system can be set an alarm if the machine is operated outside designated time.

Engine start alarm outside prescribed work time

Area Alarm

It can be set an alarm if the machine is moved out of its designated area to another location.

Alarm for outside of reset area

Specifications

Engine

Model	HINO JOSEVA-KSSA
Type	Direct Injection, water-cooled, 4cycle diesel engine with turbocharger, intercooler complies with EU stage V exhaust emission regulation
No. of cylinders	4
Bore and stroke	112 mm x 130 mm
Displacement	5.123 L
Rated power output	119 kW / 2,000 min ⁻¹ (ISO 9249 : with fan)
	124 kW / 2,000 min ⁻¹ (ISO 14396: without fan)
Max. torque	640 N•m / 1,600 min ⁻¹ (ISO 9249: with fan)
	660 N•m / 1,600 min ⁻¹ (ISO 14396: without fan)

Hydraulic system

Pump	
Type	Axial piston pumps + extra gear pump + pilot gear pump
Max. discharge flow	2 x 220 L/min, 1 x 40.6 L/min, 1 x 20 L/min
Relief valve setting	
Boom, arm and bucket	34.3 MPa {350 kgf/cm ² }
Power Boost	37.8 MPa {385 kgf/cm ² }
Travel circuit	34.3 MPa {350 kgf/cm ² }
Swing circuit	29.0 MPa {296 kgf/cm ² }
Control circuit	5.0 MPa {50 kgf/cm ² }
Pilot control pump	Gear type
Main control valve	8-Spool
Oil cooler	Air cooled type

Swing system

Swing motor	One fixed displacement piston motor
Brake	Hydraulic; locking automatically when the swing control lever is in neutral position
Parking brake	Oil disc brake, hydraulic operated automatically
Swing speed	12.7 min ⁻¹
Tail swing radius	2,910 mm
Min. front swing radius	3,550 mm
Swing torque	71.5 kN•m

Attachments

Backhoe bucket and combination

Use	Backhoe bucket			
	Normal digging			
Bucket capacity	ISO heaped	m ³	0.70	0.80
Opening width	With side cutter	mm	1,080	1,160
	Without side cutter	mm	980	1,140
No. of teeth			5	5
Bucket weight		kg	630	660
Combination	2.40 m short arm		○	○
	2.94 m standard arm		○	◎
	3.50 m long arm		◎	△

◎ Standard ○ Recommended △ Loading only

Travel system

Travel motors	2 x axial-piston, two-step motors
Travel brakes	Hydraulic brake per motor
Parking brakes	Oil disc brake per motor
Travel shoes	49 each side
Travel speed	6.0/3.6 km/h
Drawbar pulling force	228 kN (SAE)
Gradeability	70% {35°}

Cab & control

Cab

All-weather, sound-suppressed steel cab mounted on the high suspension mounts filled with silicone oil and equipped with a heavy, insulated floor mat.

Control

Two hand levers and two foot pedals for travel

Two hand levers for excavating and swing

Electric rotary-type engine throttle

Noise levels

External 100 dB(A) (2000/14/EC)

Operator 68 dB (A) (ISO 6396)

Vibration levels

Hand/arm* ≤ 2.5 m/s²

Body* ≤ 0.5 m/s²

*For the risk assessment according to 2002/44/EC, refer to ISO/TR 25398: 2006.

Boom, arm & bucket

Boom cylinders	120 mm x 1,355 mm
Arm cylinder	135 mm x 1,558 mm
Bucket cylinder	120 mm x 1,080 mm

Refilling capacities & lubrications

Fuel tank	321 L
Cooling system	19 L
Engine oil	20.5 L
Travel reduction gear	2 x 5.3 L
Swing reduction gear	1 x 2.7 L
Hydraulic oil tank	140 L tank oil level
	244 L hydraulic system
DEF/Urea tank	83 L

Working ranges

Unit: m

Boom		5.65 m		
Range		Short 2.40 m	Standard 2.94 m	Long 3.50 m
a-	Max. digging reach	9.42	9.90	10.34
b-	Max. digging reach at ground level	9.24	9.73	10.17
c-	Max. digging depth	6.16	6.70	7.26
d-	Max. digging height	9.51	9.72	9.75
e-	Max. dumping clearance	6.68	6.91	6.97
f-	Min. dumping clearance	2.98	2.43	1.87
g-	Max. vertical wall digging depth	5.57	6.10	6.47
h-	Min. swing radius	3.56	3.55	3.48
i-	Horizontal digging stroke at ground level	4.08	5.27	6.08
j-	Digging depth for 2.4 m (8') flat bottom	5.95	6.52	7.08
	Bucket capacity ISO heaped m ³	0.93	0.80	0.70

Digging Force (ISO 6015)

Unit: kN

Arm length	Short 2.40 m	Standard 2.94 m	Long 3.50 m
Bucket digging force	143 157*	143 157*	143 157*
Arm crowding force	121 133*	102 112*	91.8 101*

*Power Boost engaged.

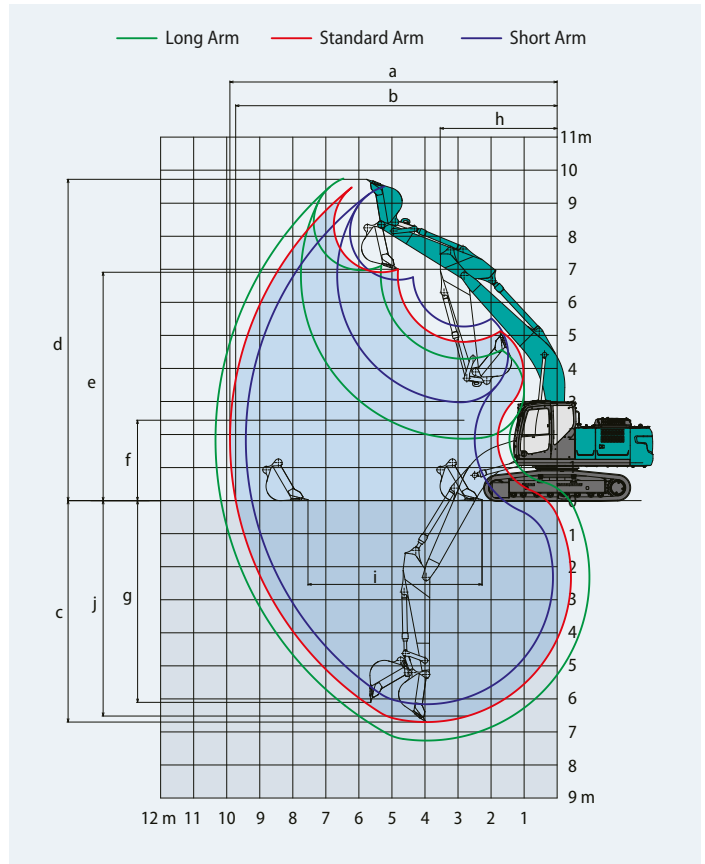

Dimensions

Arm length		Short 2.40 m	Standard 2.94 m	Long 3.50 m
A	Overall length	9,680	9,600	9,670
B	Overall height (to top of boom)	3,200	3,030	3,210
C	Overall width of crawler	SK210LC	2,990	
		SK210NLC	2,800	
D	Overall height (to top of cab)	3,060		
E	Ground clearance of rear end*	1,060		
F	Ground clearance*	425		

Unit: mm

G	Tail swing radius	2,910	
G'	Distance from centre of swing to rear end	2,900	
H	Tumbler distance	3,660	
I	Overall length of crawler	4,450	
J	Track gauge	SK210LC	2,390
		SK210NLC	2,200
K	Shoe width	600	
L	Overall width of upperstructure	2,710	

*Without including height of shoe

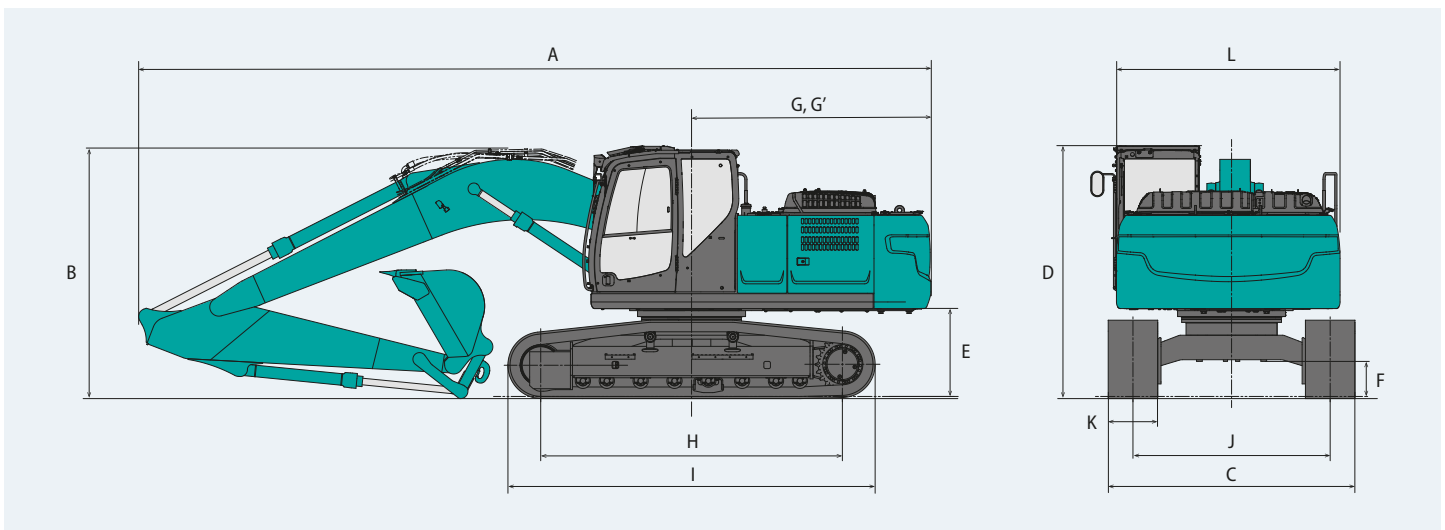

Operating weight & ground pressure

In standard trim, with standard boom, 2.94 m arm, and 0.8 m³ ISO heaped bucket.

Shaped			Triple grouser shoes (even height)			
Shoe width	mm		600	700	790	900
Overall width of crawler	SK210LC	mm	2,990	3,090	3,180	3,290
	SK210NLC	mm	2,800	2,900	2,990	—
Ground pressure	SK210LC	kPa	45	40	36	32
	SK210NLC	kPa	45	40	35	—
Operating weight	SK210LC	kg	21,900	22,400	22,600	22,900
	SK210NLC	kg	21,900	22,300	22,500	—

In standard trim, with standard boom, 2.94 m arm, and 0.8 m³ ISO heaped bucket (optional counterweight 4,900 kg).

Shaped			Triple grouser shoes (even height)			
Shoe width	mm		600	700	790	900
Overall width of crawler	SK210LC	mm	2,990	3,090	3,180	3,290
	SK210NLC	mm	2,800	2,900	2,990	—
Ground pressure	SK210LC	kPa	47	41	37	33
	SK210NLC	kPa	47	41	36	—
Operating weight	SK210LC	kg	22,500	23,000	23,200	23,500
	SK210NLC	kg	22,500	22,900	23,100	—

Lift capacities

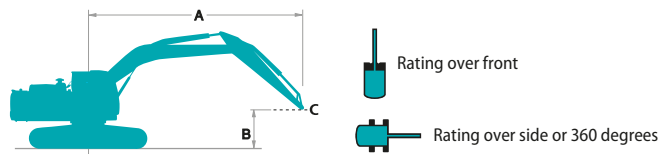

A - Reach from swing centerline to arm top
 B - Arm top height above/below ground
 C - Lift point
 Relief valve setting: 34.3 MPa

SK210LC		Boom: 5.65 m Arm: 2.94 m Bucket: without Counterweight: 4,300 kg Shoe: 600 mm (Heavy Lift)												
B \ A		1.5 m		3.0 m		4.5 m		6.0 m		7.5 m		At max. reach		Radius
7.5 m	kg							*5,300	*5,300			*4,270	*4,270	6.26 m
6.0 m	kg							*5,880	5,480			*3,940	3,850	7.36 m
4.5 m	kg							*6,420	5,280	5,680	3,680	*3,860	3,270	8.03 m
3.0 m	kg					*9,360	7,670	*7,270	5,000	5,540	3,560	*3,930	2,980	8.38 m
1.5 m	kg					*11,040	7,100	7,570	4,720	5,400	3,430	*4,170	2,870	8.45 m
G.L.	kg			*6,330	*6,330	11,660	6,790	7,360	4,530	5,290	3,330	*4,600	2,920	8.25 m
-1.5 m	kg	*6,700	*6,700	*11,060	*11,060	11,560	6,700	7,270	4,460	5,260	3,310	5,030	3,170	7.75 m
-3.0 m	kg	*11,730	*11,730	*14,650	13,240	*10,550	6,780	7,320	4,510			6,010	3,770	6.89 m
-4.5 m	kg			*10,860	*10,860	*7,950	7,050					*5,980	5,330	5.50 m

SK210LC		Boom: 5.65 m Arm: 3.50 m Bucket: without Counterweight: 4,300 kg Shoe: 600 mm (Heavy Lift)												
B \ A		1.5 m		3.0 m		4.5 m		6.0 m		7.5 m		At max. reach		Radius
7.5 m	kg											*3,640	*3,640	6.84 m
6.0 m	kg									*4,540	3,790	*3,430	*3,430	7.86 m
4.5 m	kg							*5,840	5,350	*5,440	3,710	*3,400	2,970	8.49 m
3.0 m	kg			*12,860	*12,860	*8,480	7,840	*6,750	5,050	5,550	3,560	*3,490	2,720	8.82 m
1.5 m	kg			*7,240	*7,240	*10,380	7,190	7,600	4,740	5,380	3,410	*3,710	2,610	8.89 m
G.L.	kg			*7,730	*7,730	*11,520	6,770	7,330	4,500	5,240	3,280	*4,110	2,650	8.70 m
-1.5 m	kg	*6,570	*6,570	*10,960	*10,960	11,470	6,610	7,190	4,380	5,170	3,220	4,540	2,840	8.22 m
-3.0 m	kg	*10,480	*10,480	*15,820	12,950	*11,000	6,630	7,190	4,380			5,290	3,300	7.42 m
-4.5 m	kg	*15,580	*15,580	*12,690	*12,690	*9,090	6,820	*6,410	4,540			*6,100	4,390	6.16 m

SK210LC		Boom: 5.65 m Arm: 2.40 m Bucket: without Counterweight: 4,300 kg Shoe: 600 mm (Heavy Lift)											
B	A	3.0 m		4.5 m		6.0 m		7.5 m		At max. reach		Radius	
7.5 m	kg										*6,320	6,030	5.58 m
6.0 m	kg					*6,470	5,380				*5,760	4,340	6.80 m
4.5 m	kg			*8,260	8,130	*6,930	5,210	5,620	3,630	5,590	3,610	3,610	7.52 m
3.0 m	kg			*10,100	7,490	*7,700	4,940	5,520	3,540	5,090	3,270	3,270	7.89 m
1.5 m	kg			*11,520	6,990	7,530	4,700	5,400	3,440	4,940	3,150	3,150	7.97 m
G.L.	kg			11,640	6,780	7,360	4,540	5,330	3,370	5,090	3,230	3,230	7.75 m
-1.5 m	kg	*11,440	*11,440	*11,390	6,760	7,320	4,510			5,630	3,560	3,560	7.22 m
-3.0 m	kg	*13,150	*13,150	*9,880	6,900	*7,190	4,630			*6,580	4,370	4,370	6.29 m
-4.5 m	kg			*6,230	*6,230					*5,690	*5,690	*5,690	4.72 m

SK210LC		Boom: 5.65 m Arm: 2.94 m Bucket: without Counterweight: 4,900 kg Shoe: 600 mm (Heavy Lift)												
B	A	1.5 m		3.0 m		4.5 m		6.0 m		7.5 m		At max. reach		Radius
7.5 m	kg							*5,300	*5,300			*4,270	*4,270	6.26 m
6.0 m	kg							*5,880	5,840			*3,940	*3,940	7.36 m
4.5 m	kg							*6,420	5,640	*5,910	3,960	*3,860	3,520	8.03 m
3.0 m	kg					*9,360	8,200	*7,270	5,360	5,890	3,840	*3,930	3,210	8.38 m
1.5 m	kg					*11,040	7,620	8,040	5,090	5,740	3,700	*4,170	3,110	8.45 m
G.L.	kg			*6,330	*6,330	*11,820	7,310	7,820	4,890	5,630	3,600	*4,600	3,170	8.25 m
-1.5 m	kg	*6,700	*6,700	*11,060	*11,060	*11,650	7,230	7,740	4,820	5,610	3,580	5,360	3,440	7.75 m
-3.0 m	kg	*11,730	*11,730	*14,650	14,230	*10,550	7,310	7,790	4,870			*6,330	4,080	6.89 m
-4.5 m	kg			*10,860	*10,860	*7,950	7,570					*5,980	5,730	5.50 m

SK210LC		Boom: 5.65 m Arm: 3.50 m Bucket: without Counterweight: 4,900 kg Shoe: 600 mm (Heavy Lift)												
B	A	1.5 m		3.0 m		4.5 m		6.0 m		7.5 m		At max. reach		Radius
7.5 m	kg											*3,640	*3,640	6.84 m
6.0 m	kg									*4,540	4,060	*3,430	*3,430	7.86 m
4.5 m	kg							*5,840	5,710	*5,440	3,980	*3,400	3,210	8.49 m
3.0 m	kg			*12,860	*12,860	*8,480	8,370	*6,750	5,410	*5,860	3,840	*3,490	2,940	8.82 m
1.5 m	kg			*7,240	*7,240	*10,380	7,720	*7,700	5,100	5,720	3,680	*3,710	2,840	8.89 m
G.L.	kg			*7,730	*7,730	*11,520	7,300	7,800	4,860	5,590	3,550	*4,110	2,880	8.70 m
-1.5 m	kg	*6,570	*6,570	*10,960	*10,960	*11,710	7,140	7,660	4,740	5,200	3,490	*4,820	3,080	8.22 m
-3.0 m	kg	*10,480	*10,480	*15,820	13,940	*11,000	7,160	7,660	4,740			5,640	3,580	7.42 m
-4.5 m	kg	*15,580	*15,580	*12,690	*12,690	*9,090	7,350	*6,410	4,900			*6,100	4,740	6.16 m

SK210LC		Boom: 5.65 m Arm: 2.40 m Bucket: without Counterweight: 4,900 kg Shoe: 600 mm (Heavy Lift)											
B	A	3.0 m		4.5 m		6.0 m		7.5 m		At max. reach		Radius	
7.5 m	kg										*6,320	*6,320	5.58 m
6.0 m	kg					*6,470	5,740				*5,760	4,650	6.80 m
4.5 m	kg			*8,260	*8,260	*6,930	5,570	*5,850	3,910	*5,610	3,880	3,880	7.52 m
3.0 m	kg			*10,100	8,020	*7,700	5,300	5,860	3,820	5,410	3,520	3,520	7.89 m
1.5 m	kg			*11,520	7,520	8,000	5,060	5,740	3,710	5,250	3,400	3,400	7.97 m
G.L.	kg			*11,920	7,310	7,830	4,900	5,670	3,640	5,420	3,490	3,490	7.75 m
-1.5 m	kg	*11,440	*11,440	*11,390	7,290	7,790	4,870			6,000	3,840	3,840	7.22 m
-3.0 m	kg	*13,150	*13,150	*9,880	7,430	*7,190	4,990			*6,580	4,710	4,710	6.29 m
-4.5 m	kg			*6,230	*6,230					*5,690	*5,690	*5,690	4.72 m

Notes:

- Do not attempt to lift or hold any load that is greater than these lift capacities at their specified lift point radius and heights. Weight of all accessories must be deducted from the above lift capacities.
- Lift capacities are based on machine standing on level, firm, and uniform ground. User must make allowance for job conditions such as soft or uneven ground, out of level conditions, side loads, sudden stopping of loads, hazardous conditions, experience of personnel, etc.
- Arm top defined as lift point.
- The above lift capacities are in compliance with ISO 10567. They do not exceed 87% of hydraulic lift













- capacity or 75% of tipping load. Lift capacities marked with an asterisk (*) are limited by hydraulic capacity rather than tipping load.
- Operator should be fully acquainted with the Operator's and Maintenance Instructions before operating this machine. Rules for safe operation of equipment should be adhered to at all times.
- Lift capacities apply to only machine as originally manufactured and normally equipped by KOBELCO CONSTRUCTION MACHINERY CO., LTD.











SK210NLC		Boom: 5.65 m Arm: 2.94 m Bucket: without Counterweight: 4,300 kg Shoe: 600 mm (Heavy Lift)													
B	A	1.5 m		3.0 m		4.5 m		6.0 m		7.5 m		At max. reach		Radius	
7.5 m	kg							*5,300	5,060			*4,270	*4,270	6.26 m	
6.0 m	kg							*5,880	5,050			*3,940	3,540	7.36 m	
4.5 m	kg							*6,420	4,850	5,670	3,380	*3,860	2,990	8.03 m	
3.0 m	kg						*9,360	6,980	*7,270	4,580	5,530	3,260	*3,930	2,720	8.38 m
1.5 m	kg						*11,040	6,420	7,560	4,310	5,390	3,130	*4,170	2,620	8.45 m
G.L.	kg			*6,330	*6,330	11,630	6,120	7,340	4,120	5,280	3,030	*4,600	2,660	8.25 m	
-1.5 m	kg	*6,700	*6,700	*11,060	*11,060	11,530	6,040	7,250	4,040	5,250	3,010	5,020	2,890	7.75 m	
-3.0 m	kg	*11,730	*11,730	*14,650	11,700	*10,550	6,120	7,310	4,090			6,000	3,440	6.89 m	
-4.5 m	kg			*10,860	*10,860	*7,950	6,370					*5,980	4,850	5.50 m	

SK210NLC		Boom: 5.65 m Arm: 3.50 m Bucket: without Counterweight: 4,300 kg Shoe: 600 mm (Heavy Lift)												
B	A	1.5 m		3.0 m		4.5 m		6.0 m		7.5 m		At max. reach		Radius
7.5 m	kg											*3,640	*3,640	6.84 m
6.0 m	kg									*4,540	3,480	*3,430	3,180	7.86 m
4.5 m	kg							*5,480	4,920	*5,440	3,400	*3,400	2,720	8.49 m
3.0 m	kg			*12,860	*12,860	*8,480	7,140	*6,750	4,620	5,540	3,260	*3,490	2,480	8.82 m
1.5 m	kg			*7,240	*7,240	*10,380	6,510	7,580	4,320	5,370	3,110	*3,710	2,380	8.89 m
G.L.	kg			*7,730	*7,730	*11,520	6,110	7,310	4,090	5,230	2,980	*4,110	2,400	8.70 m
-1.5 m	kg	*6,570	*6,570	*10,960	*10,960	11,440	5,950	7,180	3,970	5,160	2,920	4,530	2,580	8.22 m
-3.0 m	kg	*10,480	*10,480	*15,820	11,410	*11,000	5,970	7,170	3,970			5,280	3,000	7.42 m
-4.5 m	kg	*15,580	*15,580	*12,690	11,780	*9,090	6,150	*6,410	4,130			*6,100	3,990	6.16 m

SK210NLC		Boom: 5.65 m Arm: 2.40 m Bucket: without Counterweight: 4,300 kg Shoe: 600 mm (Heavy Lift)												
B	A	3.0 m		4.5 m		6.0 m		7.5 m		At max. reach		Radius		
7.5 m	kg											*6,320	5,550	5.58 m
6.0 m	kg											*5,760	3,990	6.80 m
4.5 m	kg			*8,260	7,430	*6,930	4,780	5,600	3,330			5,570	3,310	7.52 m
3.0 m	kg			*10,100	6,810	*7,700	4,520	5,510	3,250			5,070	2,990	7.89 m
1.5 m	kg			*11,520	6,320	7,520	4,280	5,390	3,140			4,920	2,870	7.97 m
G.L.	kg			11,610	6,110	7,350	4,130	5,310	3,070			5,070	2,940	7.75 m
-1.5 m	kg	*11,440	*11,440	*11,390	6,100	7,310	4,100					5,620	3,240	7.22 m
-3.0 m	kg	*13,150	11,920	*9,880	6,240	*7,190	4,210					*6,580	3,990	6.29 m
-4.5 m	kg			*6,230	*6,230							*5,690	*5,690	4.72 m

SK210NLC		Boom: 5.65 m Arm: 2.94 m Bucket: without Counterweight: 4,900 kg Shoe: 600 mm (Heavy Lift)												
B	A	1.5 m		3.0 m		4.5 m		6.0 m		7.5 m		At max. reach		Radius
7.5 m	kg							*5,300	*5,300			*4,270	*4,270	6.26 m
6.0 m	kg							*5,880	5,390			*3,940	3,810	7.36 m
4.5 m	kg							*6,420	5,200	*5,910	3,650	*3,860	3,240	8.03 m
3.0 m	kg					*9,360	7,480	*7,270	4,920	5,880	3,530	*3,930	2,950	8.38 m
1.5 m	kg					*11,040	6,920	8,020	4,650	5,730	3,390	*4,170	2,840	8.45 m
G.L.	kg			*6,330	*6,330	*11,820	6,620	7,810	4,470	5,620	3,300	*4,600	2,900	8.25 m
-1.5 m	kg	*6,700	*6,700	*11,060	*11,060	*11,650	6,540	7,720	4,390	5,600	3,270	5,350	3,140	7.75 m
-3.0 m	kg	*11,730	*11,730	*14,650	12,610	*10,550	6,620	7,780	4,440			*6,330	3,730	6.89 m
-4.5 m	kg			*10,860	*10,860	*7,950	6,870					*5,980	5,230	5.50 m

SK210NLC		Boom: 5.65 m Arm: 3.50 m Bucket: without Counterweight: 4,900 kg Shoe: 600 mm (Heavy Lift)													
B	A	1.5 m		3.0 m		4.5 m		6.0 m		7.5 m		At max. reach		Radius	
															
7.5 m	kg												*3,640	*3,640	6.84 m
6.0 m	kg									*4,540	3,740		*3,430	3,430	7.86 m
4.5 m	kg							*5,840	5,260	*5,440	3,670		*3,400	2,950	8.49 m
3.0 m	kg			*12,860	*12,860	*8,480	7,640	*6,750	4,970	*5,860	3,520		*3,490	2,700	8.82 m
1.5 m	kg			*7,240	*7,240	*10,380	7,010	*7,700	4,660	*5,710	3,370		*3,710	2,590	8.89 m
G.L.	kg			*7,730	*7,730	*11,520	6,610	7,780	4,430	5,570	3,240		*4,110	2,620	8.70 m
-1.5 m	kg	*6,570	*6,570	*10,960	*10,960	*11,710	6,450	7,640	4,310	5,500	3,180		*4,820	2,810	8.22 m
-3.0 m	kg	*10,480	*10,480	*15,820	12,330	*11,000	6,470	7,640	4,310				5,620	3,260	7.42 m
-4.5 m	kg	*15,580	*15,580	*12,690	*12,690	*9,090	6,650	*6,410	4,470				*6,100	4,320	6.16 m

SK210NLC		Boom: 5.65 m Arm: 2.40 m Bucket: without Counterweight: 4,900 kg Shoe: 600 mm (Heavy Lift)													
B	A	3.0 m		4.5 m		6.0 m		7.5 m		At max. reach		Radius			
															
7.5 m	kg												*6,320	5,920	5.58 m
6.0 m	kg					*6,470	5,300						*5,760	4,280	6.80 m
4.5 m	kg			*8,260	7,930	*6,930	5,130	*5,850	3,600	*5,610	3,570		*5,610	3,570	7.52 m
3.0 m	kg			*10,100	7,310	*7,700	4,870	5,850	3,510	5,400	3,240		5,400	3,240	7.89 m
1.5 m	kg			*11,520	6,820	7,990	4,630	5,730	3,400	5,240	3,120		5,240	3,120	7.97 m
G.L.	kg			*11,920	6,620	7,810	4,480	5,660	3,330	5,400	3,200		5,400	3,200	7.75 m
-1.5 m	kg	*11,440	*11,440	*11,390	6,600	7,780	4,440						5,980	3,520	7.22 m
-3.0 m	kg	*13,150	12,830	*9,880	6,740	*7,190	4,560						*6,580	4,310	6.29 m
-4.5 m	kg			*6,230	*6,230								*5,690	*5,690	4.72 m

Notes:

- Do not attempt to lift or hold any load that is greater than these lift capacities at their specified lift point radius and heights. Weight of all accessories must be deducted from the above lift capacities.
- Lift capacities are based on machine standing on level, firm, and uniform ground. User must make allowance for job conditions such as soft or uneven ground, out of level conditions, side loads, sudden stopping of loads, hazardous conditions, experience of personnel, etc.
- Arm top defined as lift point.
- The above lift capacities are in compliance with ISO 10567. They do not exceed 87% of hydraulic lift capacity or 75% of tipping load. Lift capacities marked with an asterisk (*) are limited by hydraulic capacity rather than tipping load.
- Operator should be fully acquainted with the Operator's and Maintenance Instructions before operating this machine. Rules for safe operation of equipment should be adhered to at all times.
- Lift capacities apply to only machine as originally manufactured and normally equipped by KOBELCO CONSTRUCTION MACHINERY CO., LTD.

2 Piece Boom Specifications

Engine

Model	HINO JO5EVA-KSSA
Type	Direct Injection, water-cooled, 4cycle diesel engine with turbocharger, intercooler complies with EU stage V exhaust emission regulation
No. of cylinders	4
Bore and stroke	112 mm x 130 mm
Displacement	5.123 L
Rated power output	119 kW / 2,000 min ⁻¹ (ISO 9249: with fan)
	124 kW / 2,000 min ⁻¹ (ISO 14396: without fan)
Max. torque	640 N·m / 1,600 min ⁻¹ (ISO 9249: with fan)
	660 N·m / 1,600 min ⁻¹ (ISO 14396: without fan)

Hydraulic system

Pump	
Type	Axial piston pumps + extra gear pump + pilot gear pump
Max. discharge flow	2 × 220 L/min , 1 × 40.6 L/min , 1 × 20 L/min
Relief valve setting	
Boom, arm and bucket	34.3 MPa {350 kgf/cm ² }
Power Boost	37.8 MPa {385 kgf/cm ² }
Travel circuit	34.3 MPa {350 kgf/cm ² }
Swing circuit	29.0 MPa {296 kgf/cm ² }
Control circuit	5.0 MPa {50 kgf/cm ² }
Pilot control pump	Gear type
Main control valve	8 - Spool valve
Oil cooler	Air cooled type

Swing system

Swing motor	One fixed displacement piston motor
Brake	Hydraulic;locking automatically when the swing control lever is in neutral position
Parking brake	Wet multiple plate
Swing speed	12.7 min ⁻¹
Tail swing radius	2,910 mm
Min. front swing radius	3,550 mm
Swing torque	71.5 kNm

Attachments

Backhoe bucket and combination

Use	Backhoe bucket			
	Normal digging			
Bucket capacity	ISO heaped	m ³	0.70	0.80
Opening width	With side cutter	mm	1,080	1,160
	Without side cutter	mm	980	1,140
No. of teeth			5	5
Bucket weight		kg	630	660
Combination	2.40 m short arm		○	○
	2.94 m standard arm		○	◎
	3.50 m long arm		◎	△

◎ Standard ○ Recommended △ Loading only

Travel system

Travel motors	2 × axial-piston, two-step motors
Travel brakes	Hydraulic break
Parking brakes	Oil disc brake per motor
Travel shoes	49 each side
Travel speed (high/low)	6.0 / 3.6 km/h
Drawbar pulling force	228 kN (SAE)
Gradeability	70% {35°}

Cab & control

Cab	
All-weather, sound-suppressed steel cab mounted on the silicon-sealed viscous mounts and equipped with a heavy, insulated floor mat.	
Control	
Two hand levers and two pedals for travel	
Two hand levers for excavating and swing	
Electric rotary-type engine throttle	
Noise levels	
External	100 dB(A) (2000/14/EC)
Operator	68 dB (A) (ISO 6396)
Vibration levels	
Hand/arm*	≤ 2.5 m/s ²
Body*	≤ 0.5 m/s ²

*For the risk assessment according to 2002/44/EC, refer to ISO/TR 25398: 2006.

Boom, arm & bucket

Boom cylinders	120 mm × 1,355 mm
Arm cylinder	135 mm × 1,558 mm
Bucket cylinder	120 mm × 1,080 mm
Jib cylinder	150 mm × 992 mm

Refilling capacities & lubrications

Fuel tank	321 L
Cooling system	19 L
Engine oil	20.5 L
Travel reduction gear	2 × 5.3 L
Swing reduction gear	1 × 2.7 L
Hydraulic oil tank	140 L tank oil level
	244 L hydraulic system
DEF/Urea tank	83 L

Working ranges

Unit: m

Boom		3.16 m + 2.63 m		
Range		Short 2.40 m	Standard 2.94 m	Long 3.50 m
a-	Max. digging reach	9.57	10.07	10.53
b-	Max. digging reach at ground level	9.39	9.90	10.37
c-	Max. digging depth	5.89	6.42	6.93
d-	Max. digging height	10.83	11.23	11.50
e-	Max. dumping clearance	7.95	8.35	8.62
f-	Min. dumping clearance	1.51	0.97	0.41
g-	Max. vertical wall digging depth	5.07	5.58	6.02
h-	Min. swing radius	2.76	2.55	2.72
i-	Horizontal digging stroke at ground level	5.77	6.80	7.80
j-	Digging depth for 2.4 m (8') flat bottom	5.78	6.31	6.83
Bucket capacity ISO heaped m ³		0.93	0.80	0.70

Digging Force (ISO 6015)

Unit: kN

Arm length	Short 2.40 m	Standard 2.94 m	Long 3.50 m
Bucket digging force	143 157*	143 157*	143 157*
Arm crowding force	121 133*	102 112*	91.8 101*

*Power Boost engaged.

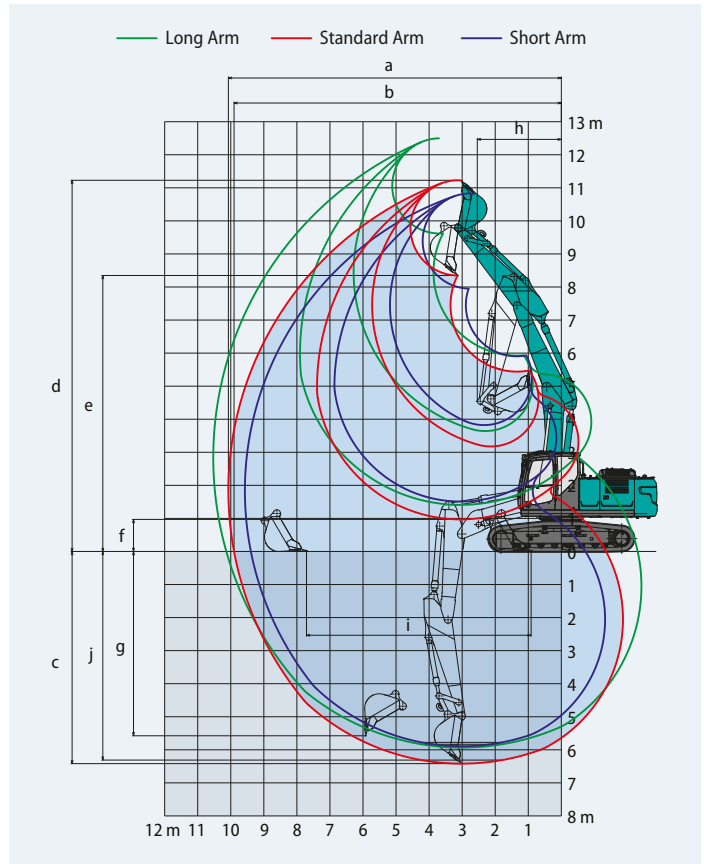

Dimensions

Arm length		Short 2.40 m	Standard 2.94 m	Long 3.50 m
A	Overall length	9,760	9,740	9,730
B	Overall height (to top of boom)	3,030	2,970	3,280
C	Overall width of crawler	SK210LC	2,990	
		SK210NLC	2,800	
D	Overall height (to top of cab)	3,060		
E	Ground clearance of rear end*	1,060		
F	Ground clearance*	425		

Unit: mm

G	Tail swing radius	2,910	
G'	Distance from centre of swing to rear end	2,900	
H	Tumbler distance	3,660	
I	Overall length of crawler	4,450	
J	Track gauge	SK210LC	2,390
		SK210NLC	2,200
K	Shoe width	600	
L	Overall width of upperstructure	2,710	

*Without including height of shoe

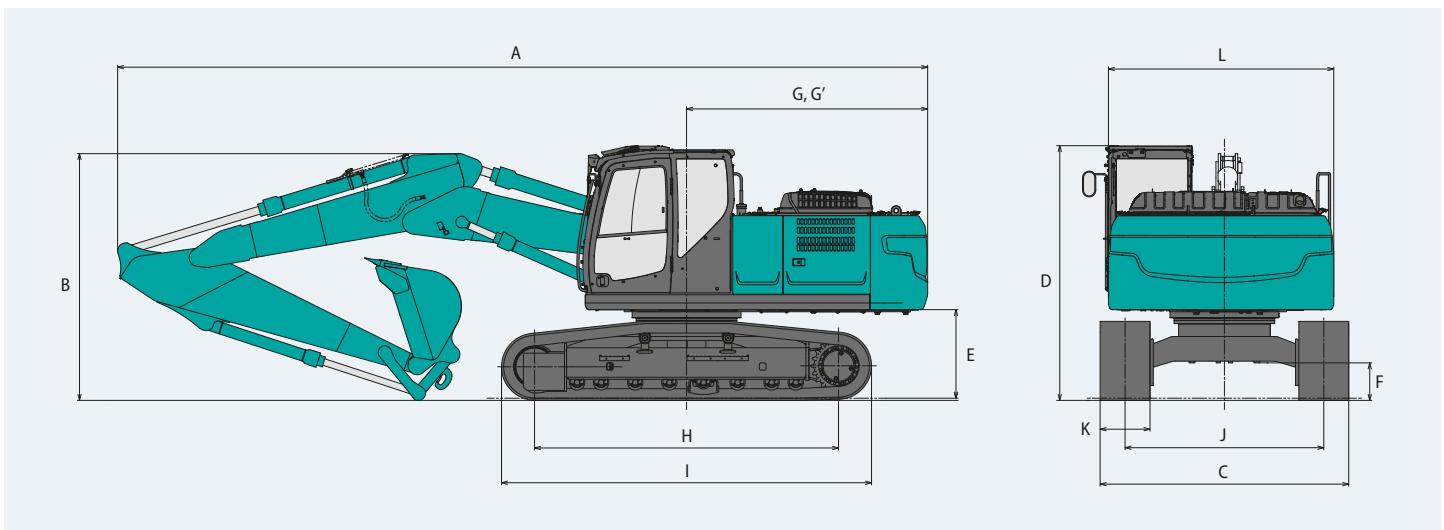

Operating weight & ground pressure

In standard trim, with 2 piece boom, 2.94 m arm, and 0.8 m³ ISO heaped bucket.

Shaped			Triple grouser shoes (even height)			
Shoe width	mm		600	700	790	900
Overall width of crawler	SK210LC	mm	2,990	3,090	3,180	3,290
	SK210NLC	mm	2,800	2,900	2,990	—
Ground pressure	SK210LC	kPa	48	42	37	33
	SK210NLC	kPa	47	41	37	—
Operating weight	SK210LC	kg	22,900	23,400	22,600	23,900
	SK210NLC	kg	22,800	23,300	23,500	—

In standard trim, with 2 piece boom, 2.94 m arm, and 0.8 m³ ISO heaped bucket (optional counterweight 4,900 kg).

Shaped			Triple grouser shoes (even height)			
Shoe width	mm		600	700	790	900
Overall width of crawler	SK210LC	mm	2,990	3,090	3,180	3,290
	SK210NLC	mm	2,800	2,900	2,990	—
Ground pressure	SK210LC	kPa	48	42	37	33
	SK210NLC	kPa	47	42	37	—
Operating weight	SK210LC	kg	23,500	24,000	24,200	24,500
	SK210NLC	kg	23,400	23,900	24,100	—

Lift capacities

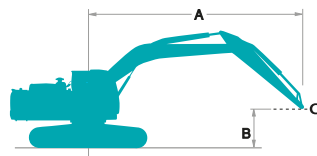

Rating over front

Rating over side or 360 degrees

A - Reach from swing centerline to arm top
B - Arm top height above/below ground
C - Lift point

Relief valve setting: 34.3 MPa

SK210LC		2 piece boom		Arm: 2.94 m		Bucket: without		Counterweight: 4,300 kg		Shoe: 600 mm (Heavy Lift)					
B	A	1.5 m		3.0 m		4.5 m		6.0 m		7.5 m		At max. reach		Radius	
9.0 m	kg					*5,880	*5,880					*4,930	*4,930	4.74 m	
7.5 m	kg					*6,770	*6,770	*5,680	5,440			*4,040	*4,040	6.49 m	
6.0 m	kg					*6,870	*6,870	*4,620	*4,620	*4,100	3,600	*3,700	3,550	7.55 m	
4.5 m	kg			*10,460	*10,460	*9,180	8,220	*7,630	5,170	*4,820	3,560	*3,580	3,000	8.21 m	
3.0 m	kg	*31,510	*31,510	*16,370	14,230	*10,810	7,440	7,780	4,830	*4,780	3,410	*3,610	2,720	8.55 m	
1.5 m	kg			*17,860	12,690	*11,550	6,750	7,410	4,500	*5,140	3,250	*3,770	2,620	8.62 m	
G.L.	kg	*19,950	*19,950	*14,860	12,300	*11,200	6,410	7,160	4,280	5,140	3,140	*4,100	2,670	8.42 m	
-1.5 m	kg			*10,000	*10,000	*9,830	6,330	7,070	4,200	5,120	3,110	*4,690	2,910	7.93 m	
-3.0 m	kg			*8,590	*8,590	*7,430	6,450	*5,640	4,270			*3,780	3,460	7.10 m	
-4.5 m	kg			*11,920	*11,920	*6,720	*6,720					*1,810	*1,810	5.76 m	

SK210LC		2 piece boom		Arm: 3.50 m		Bucket: without		Counterweight: 4,300 kg		Shoe: 600 mm (Heavy Lift)						
B	A	1.5 m		3.0 m		4.5 m		6.0 m		7.5 m		9.0 m		At max. reach		Radius
9.0 m	kg					*5,740	*5,740							*4,030	*4,030	5.53 m
7.5 m	kg							*4,890	*4,890					*3,460	*3,460	7.09 m
6.0 m	kg							*5,890	5,520	*4,460	3,700			*3,240	3,180	8.07 m
4.5 m	kg					*6,900	*6,900	*6,880	5,270	*4,150	3,600			*3,170	2,720	8.69 m
3.0 m	kg	*27,450	*27,450	*15,750	14,900	*10,210	7,660	*7,810	4,900	*4,070	3,420	*3,330	2,490	*3,230	2,480	9.01 m
1.5 m	kg	*18,250	*18,250	*17,840	13,000	*11,280	6,880	7,450	4,530	*4,400	3,240	*3,890	2,410	*3,390	2,380	9.08 m
G.L.	kg	*19,130	*19,130	*6,700	*6,700	*11,360	6,410	7,140	4,260	5,100	3,090			*3,710	2,400	8.89 m
-1.5 m	kg			*9,990	*9,990	*10,390	6,230	6,990	4,120	5,020	3,020			*4,220	2,580	8.43 m
-3.0 m	kg			*10,660	*10,660	*8,420	6,280	*6,380	4,130	*4,300	3,070			*4,000	3,000	7.65 m
-4.5 m	kg			*14,570	13,100	*5,130	*5,130	*4,490	4,340					*2,700	*2,700	6.43 m

SK210LC		2 piece boom Arm: 2.40 m Bucket: without Counterweight: 4,300 kg Shoe: 600 mm (Heavy Lift)													
B	A	1.5 m		3.0 m		4.5 m		6.0 m		7.5 m		At max. reach		Radius	
9.0 m	kg												*7,980	*7,980	3.73 m
7.5 m	kg					*8,830	8,770						*6,060	5,550	5.80 m
6.0 m	kg					*9,000	8,570	*5,580	5,290				*5,130	4,010	6.97 m
4.5 m	kg			*14,150	*14,150	*10,110	7,990	*4,770	*4,770	*5,240	3,490		*4,720	3,330	7.68 m
3.0 m	kg			*15,800	14,260	*11,250	7,210	7,690	4,750	*5,400	3,380		*4,580	3,000	8.05 m
1.5 m	kg			*17,890	12,860	11,600	6,630	7,360	4,460	5,260	3,250		*4,650	2,890	8.12 m
G.L.	kg	*25,320	*25,320	*15,660	12,430	*10,800	6,400	7,160	4,290	5,180	3,170		4,810	2,960	7.91 m
-1.5 m	kg			*9,810	*9,810	*9,050	6,410	*7,020	4,260				*4,810	3,270	7.39 m
-3.0 m	kg					*6,250	*6,250	*4,580	4,400				*3,540	*3,540	6.48 m

SK210LC		2 piece boom Arm: 2.94 m Bucket: without Counterweight: 4,900 kg Shoe: 600 mm (Heavy Lift)													
B	A	1.5 m		3.0 m		4.5 m		6.0 m		7.5 m		At max. reach		Radius	
9.0 m	kg					*5,880	*5,880						*4,930	*4,930	4.74 m
7.5 m	kg					*6,770	*6,770	*5,680	*5,680				*4,040	*4,040	6.49 m
6.0 m	kg					*6,870	*6,870	*4,620	*4,620	*4,100	3,880		*3,700	*3,700	7.55 m
4.5 m	kg			*10,460	*10,460	*9,180	8,750	*7,630	5,530	*4,820	3,830		*3,580	3,520	8.21 m
3.0 m	kg	*31,510	*31,510	*16,370	15,220	*10,810	7,960	*8,150	5,190	*4,780	3,680		*3,610	2,960	8.55 m
1.5 m	kg			*17,860	13,680	*11,550	7,280	7,880	4,860	*5,140	3,520		*3,770	2,850	8.62 m
G.L.	kg	*19,950	*19,950	*14,860	13,290	*11,200	6,940	7,630	4,640	5,490	3,410		*4,100	2,910	8.42 m
-1.5 m	kg			*10,000	*10,000	*9,830	6,860	*7,480	4,560	5,460	3,390		*4,690	3,160	7.93 m
-3.0 m	kg			*8,590	*8,590	*7,430	6,980	*5,640	4,630				*3,780	3,750	7.10 m
-4.5 m	kg			*11,920	*11,920	*6,720	*6,720						*1,810	*1,810	5.76 m













SK210LC		2 piece boom Arm: 3.50 m Bucket: without Counterweight: 4,900 kg Shoe: 600 mm (Heavy Lift)														
B	A	1.5 m		3.0 m		4.5 m		6.0 m		7.5 m		9.0 m		At max. reach		Radius
9.0 m	kg					*5,740	*5,740							*4,030	*4,030	5.53 m
7.5 m	kg							*4,890	*4,890					*3,460	*3,460	7.09 m
6.0 m	kg							*5,890	5,880	*4,460	3,970			*3,240	*3,240	8.07 m
4.5 m	kg					*6,900	*6,900	*6,880	5,630	*4,150	3,870			*3,170	2,950	8.69 m
3.0 m	kg	*27,450	*27,450	*15,750	*15,750	*10,210	8,190	*7,810	5,260	*4,070	3,700	*3,330	2,710	*3,230	2,700	9.01 m
1.5 m	kg	*18,250	*18,250	*17,840	13,990	*11,280	7,410	7,920	4,890	*4,400	3,510	*3,890	2,630	*3,390	2,600	9.08 m
G.L.	kg	*19,130	*19,130	*6,700	*6,700	*11,360	6,930	7,610	4,620	*5,180	3,360			*3,710	2,630	8.89 m
-1.5 m	kg			*9,990	*9,990	*10,390	6,760	7,460	4,480	5,370	3,290			*4,220	2,820	8.43 m
-3.0 m	kg			*10,660	*10,660	*8,420	6,810	*6,380	4,490	*4,300	3,350			*4,000	3,270	7.65 m
-4.5 m	kg			*14,570	14,090	*5,130	*5,130	*4,490	*4,490					*2,700	*2,700	6.43 m













SK210LC		2 piece boom Arm: 2.40 m Bucket: without Counterweight: 4,900 kg Shoe: 600 mm (Heavy Lift)													
B	A	1.5 m		3.0 m		4.5 m		6.0 m		7.5 m		At max. reach		Radius	
9.0 m	kg												*7,980	*7,980	3.73 m
7.5 m	kg					*8,830	*8,830						*6,060	5,920	5.80 m
6.0 m	kg					*9,000	*9,000	*5,580	*5,580				*5,130	4,310	6.97 m
4.5 m	kg			*14,150	*14,150	*10,110	8,520	*4,770	*4,770	*5,240	3,760		*4,720	3,600	7.68 m
3.0 m	kg			*15,800	15,250	*11,250	7,740	8,150	5,110	*5,500	3,650		*4,580	3,250	8.05 m
1.5 m	kg			*17,890	13,850	*11,600	7,160	7,830	4,820	5,610	3,520		*4,650	3,140	8.12 m
G.L.	kg	*25,320	*25,320	*15,660	13,420	*10,800	6,930	7,630	4,650	5,520	3,450		*4,930	3,220	7.91 m
-1.5 m	kg			*9,810	*9,810	*9,050	6,940	*7,020	4,620				*4,810	3,550	7.39 m
-3.0 m	kg					*6,250	*6,250	*4,580	*4,580				*3,540	*3,540	6.48 m













Notes:













- Do not attempt to lift or hold any load that is greater than these lift capacities at their specified lift point radius and heights. Weight of all accessories must be deducted from the above lift capacities.
- Lift capacities are based on machine standing on level, firm, and uniform ground. User must make allowance for job conditions such as soft or uneven ground, out of level conditions, side loads, sudden stopping of loads, hazardous conditions, experience of personnel, etc.
- Arm top defined as lift point.
- The above lift capacities are in compliance with ISO 10567. They do not exceed 87% of hydraulic lift















- capacity or 75% of tipping load. Lift capacities marked with an asterisk (*) are limited by hydraulic capacity rather than tipping load.
- Operator should be fully acquainted with the Operator's and Maintenance Instructions before operating this machine. Rules for safe operation of equipment should be adhered to at all times.
- Lift capacities apply to only machine as originally manufactured and normally equipped by KOBELCO CONSTRUCTION MACHINERY CO., LTD.















SK210NLC		2 piece boom Arm: 2.94 m Bucket: without Counterweight: 4,300 kg Shoe: 600 mm (Heavy Lift)												
B	A	1.5 m		3.0 m		4.5 m		6.0 m		7.5 m		At max. reach		Radius
														
9.0 m	kg					*5,880	*5,880					*4,930	*4,930	4.74 m
7.5 m	kg					*6,770	*6,770	*5,680	5,000			*4,040	*4,040	6.49 m
6.0 m	kg					*6,870	*6,870	*4,620	*4,620	*4,100	3,290	*3,700	3,240	7.55 m
4.5 m	kg			*10,460	*10,460	*9,180	7,500	*7,630	4,730	*4,820	3,250	*3,580	2,730	8.21 m
3.0 m	kg	*31,510	*31,510	*16,370	12,600	*10,810	6,730	7,760	4,400	*4,780	3,100	*3,610	2,470	8.55 m
1.5 m	kg			*17,860	11,140	*11,550	6,070	7,390	4,070	*5,140	2,940	*3,770	2,370	8.62 m
G.L.	kg	*19,950	*19,950	*14,860	10,760	*11,200	5,730	7,140	3,860	5,130	2,830	*4,100	2,410	8.42 m
-1.5 m	kg			*10,000	*10,000	*9,830	5,660	7,050	3,780	5,100	2,810	*4,690	2,630	7.93 m
-3.0 m	kg			*8,590	*8,590	*7,430	5,770	*5,640	3,850			*3,780	3,130	7.10 m
-4.5 m	kg			*11,920	11,800	*6,720	6,140					*1,810	*1,810	5.76 m

SK210NLC		2 piece boom Arm: 3.50 m Bucket: without Counterweight: 4,300 kg Shoe: 600 mm (Heavy Lift)														
B	A	1.5 m		3.0 m		4.5 m		6.0 m		7.5 m		9.0 m		At max. reach		Radius
																
9.0 m	kg					*5,740	*5,740							*4,030	*4,030	5.53 m
7.5 m	kg							*4,890	*4,890					*3,460	*3,460	7.09 m
6.0 m	kg							*5,890	5,070	*4,460	3,390			*3,240	2,900	8.07 m
4.5 m	kg					*6,900	*6,900	*6,880	4,820	*4,150	3,290			*3,170	2,470	8.69 m
3.0 m	kg	*27,450	*27,450	*15,750	13,230	*10,210	6,950	*7,810	4,460	*4,070	3,120	*3,330	2,250	*3,230	2,240	9.01 m
1.5 m	kg	*18,250	*18,250	*17,840	11,430	*11,280	6,190	7,440	4,100	*4,400	2,930	*3,890	2,180	*3,390	2,140	9.08 m
G.L.	kg	*19,130	*19,130	*6,700	*6,700	11,330	5,730	7,130	3,830	5,090	2,780			*3,710	2,160	8.89 m
-1.5 m	kg			*9,990	*9,990	*10,390	5,560	6,970	3,700	5,010	2,720			*4,220	2,330	8.43 m
-3.0 m	kg			*10,660	*10,660	*8,420	5,610	*6,380	3,710	*4,300	2,770			*4,000	2,710	7.65 m
-4.5 m	kg			*14,570	11,520	*5,130	*5,130	*4,490	3,910					*2,700	*2,700	6.43 m

SK210NLC		2 piece boom Arm: 2.40 m Bucket: without Counterweight: 4,300 kg Shoe: 600 mm (Heavy Lift)														
B	A	1.5 m		3.0 m		4.5 m		6.0 m		7.5 m		At max. reach		Radius		
																
9.0 m	kg													*7,980	*7,980	3.73 m
7.5 m	kg					*8,830	8,040							*6,060	5,080	5.80 m
6.0 m	kg					*9,000	7,840	*5,580	4,850					*5,130	3,670	6.97 m
4.5 m	kg			*14,150	*14,150	*10,110	7,270	*4,770	4,630	*5,240	3,180	*4,720	3,030	*4,720	3,030	7.68 m
3.0 m	kg			*15,800	12,620	*11,250	6,520	7,670	4,320	5,390	3,070	*4,580	2,730	*4,580	2,730	8.05 m
1.5 m	kg			*17,890	11,300	11,580	5,950	7,340	4,040	5,250	2,940	*4,650	2,620	*4,650	2,620	8.12 m
G.L.	kg	*25,320	*25,320	*15,660	10,890	*10,800	5,730	7,150	3,870	5,170	2,870	4,800	2,680	4,800	2,680	7.91 m
-1.5 m	kg			*9,810	*9,810	*9,050	5,740	*7,020	3,840			*4,810	2,960	*4,810	2,960	7.39 m
-3.0 m	kg					*6,250	5,920	*4,580	3,980			*3,540	*3,540	*3,540	*3,540	6.48 m

SK210NLC		2 piece boom Arm: 2.94 m Bucket: without Counterweight: 4,900 kg Shoe: 600 mm (Heavy Lift)														
B	A	1.5 m		3.0 m		4.5 m		6.0 m		7.5 m		At max. reach		Radius		
																
9.0 m	kg					*5,880	*5,880							*4,930	*4,930	4.74 m
7.5 m	kg					*6,770	*6,770	*5,680	5,340					*4,040	*4,040	6.49 m
6.0 m	kg					*6,870	*6,870	*4,620	*4,620	*4,100	3,560			*3,700	3,500	7.55 m
4.5 m	kg			*10,460	*10,460	*9,180	8,000	*7,630	5,080	*4,820	3,510	*3,580	2,970	*3,580	2,970	8.21 m
3.0 m	kg	*31,510	*31,510	*16,370	13,510	*10,810	7,230	*8,150	4,740	*4,780	3,360	*3,610	2,690	*3,610	2,690	8.55 m
1.5 m	kg			*17,860	12,050	*11,550	6,570	7,860	4,420	*5,140	3,210	*3,770	2,590	*3,770	2,590	8.62 m
G.L.	kg	*19,950	*19,950	*14,860	11,680	*11,200	6,230	7,610	4,200	5,470	3,090	*4,100	2,640	*4,100	2,640	8.42 m
-1.5 m	kg			*10,000	*10,000	*9,830	6,160	*7,480	4,120	5,450	3,070	*4,680	2,870	*4,680	2,870	7.93 m
-3.0 m	kg			*8,590	*8,590	*7,430	6,270	*5,640	4,190			*3,780	3,410	*3,780	3,410	7.10 m
-4.5 m	kg			*11,920	*11,920	*6,720	6,640					*1,810	*1,810	*1,810	*1,810	5.76 m

SK210NLC		2 piece boom Arm: 3.50 m Bucket: without Counterweight: 4,900 kg Shoe: 600 mm (Heavy Lift)														
B	A	1.5 m		3.0 m		4.5 m		6.0 m		7.5 m		9.0 m		At max. reach		Radius
																
9.0 m	kg					*5,740	*5,740							*4,030	*4,030	5.53 m
7.5 m	kg							*4,890	*4,890					*3,460	*3,460	7.09 m
6.0 m	kg							*5,890	5,420	*4,460	3,650			*3,240	3,140	8.07 m
4.5 m	kg					*6,900	*6,900	*6,880	5,170	*4,150	3,550			*3,170	2,690	8.69 m
3.0 m	kg	*27,450	*27,450	*15,750	14,140	*10,210	7,450	*7,810	4,810	*4,070	3,380	*3,330	2,460	*3,230	2,450	9.01 m
1.5 m	kg	*18,250	*18,250	*17,840	12,340	*11,280	6,690	7,910	4,450	*4,400	3,190	*3,890	2,390	*3,390	2,350	9.08 m
G.L.	kg	*19,130	*19,130	*6,700	*6,700	*11,360	6,230	7,590	4,180	*5,180	3,050			*3,710	2,380	8.89 m
-1.5 m	kg			*9,990	*9,990	*10,390	6,070	7,440	4,050	5,350	2,980			*4,220	2,550	8.43 m
-3.0 m	kg			*10,660	*10,660	*8,420	6,110	*6,380	4,060	*4,300	3,030			*4,000	2,970	7.65 m
-4.5 m	kg			*14,570	12,430	*5,130	*5,130	*4,490	4,260					*2,700	*2,700	6.43 m

SK210NLC		2 piece boom Arm: 2.40 m Bucket: without Counterweight: 4,900 kg Shoe: 600 mm (Heavy Lift)														
B	A	1.5 m		3.0 m		4.5 m		6.0 m		7.5 m		At max. reach		Radius		
																
9.0 m	kg													*7,980	*7,980	3.73 m
7.5 m	kg					*8,830	8,540							*6,060	5,440	5.80 m
6.0 m	kg					*9,000	8,340	5,580	5,190					*5,130	3,950	6.97 m
4.5 m	kg			*14,150	*14,150	*10,110	7,770	*4,770	*4,770	*5,240	3,440			*4,720	3,290	7.68 m
3.0 m	kg			*15,800	13,530	*11,250	7,020	8,140	4,670	*5,500	3,330			*4,580	2,970	8.05 m
1.5 m	kg			*17,890	12,210	*11,600	6,450	7,810	4,380	5,590	3,210			*4,650	2,860	8.12 m
G.L.	kg	*25,320	*25,320	*15,660	11,800	*10,800	6,230	7,610	4,210	5,510	3,130			*4,930	2,930	7.91 m
-1.5 m	kg			*9,810	*9,810	*9,050	6,240	*7,020	4,190					*4,810	3,230	7.39 m
-3.0 m	kg					*6,250	*6,250	*4,580	4,330					*3,540	*3,540	6.48 m

Notes:

- Do not attempt to lift or hold any load that is greater than these lift capacities at their specified lift point radius and heights. Weight of all accessories must be deducted from the above lift capacities.
- Lift capacities are based on machine standing on level, firm, and uniform ground. User must make allowance for job conditions such as soft or uneven ground, out of level conditions, side loads, sudden stopping of loads, hazardous conditions, experience of personnel, etc.
- Arm top defined as lift point.
- The above lift capacities are in compliance with ISO 10567. They do not exceed 87% of hydraulic lift

- capacity or 75% of tipping load. Lift capacities marked with an asterisk (*) are limited by hydraulic capacity rather than tipping load.
- Operator should be fully acquainted with the Operator's and Maintenance Instructions before operating this machine. Rules for safe operation of equipment should be adhered to at all times.
- Lift capacities apply to only machine as originally manufactured and normally equipped by KOBELCO CONSTRUCTION MACHINERY CO., LTD.

Long Reach Attachment Specifications



Main Specifications

Model	SK210LC
Long reach attachment	50ft
Engine	HINO J05EVA-KSSA
Rated power output	119 kW / 2,000 min ⁻¹ (ISO 9249: with fan) 124 kW / 2,000 min ⁻¹ (ISO14396: without fan)
Swing speed	12.7 min ⁻¹
Operating weight	23,400 kg
Ground pressure	49 kPa
A Overall length	12,690 mm
B Overall height	3,160 mm
C Overall width	2,990 mm
D Shoe width	600 mm

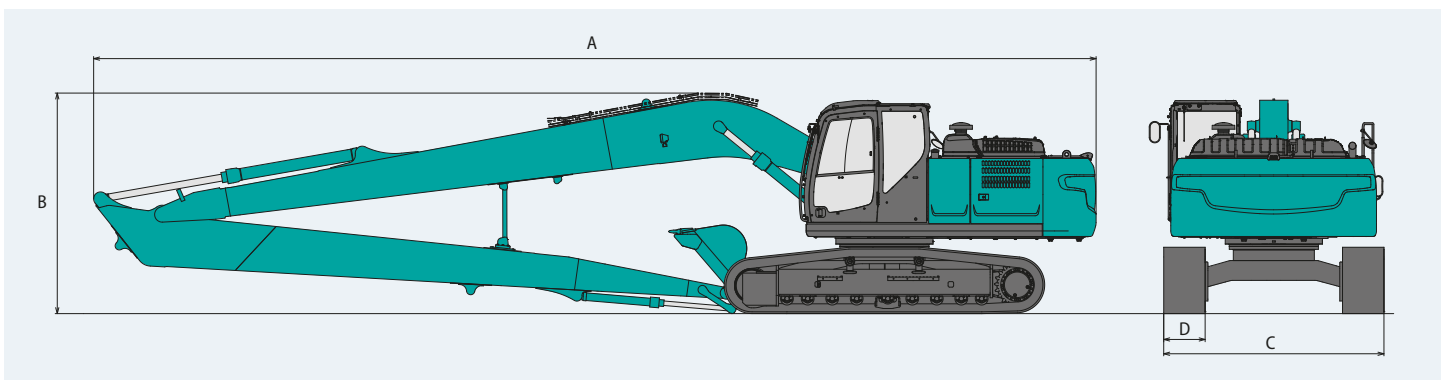

Boom, arm & bucket

Boom cylinders	120 mm × 1,355 mm
Arm cylinder	135 mm × 1,489 mm
Bucket cylinder	111 mm × 885 mm



Working ranges

Unit: m

		SK210LC
Boom		8.75 m
Range	Arm	6.35 m
a- Max. digging reach		15.82
b- Max. digging reach at ground level		15.71
c- Max. digging depth		12.01
d- Max. digging height		13.90
e- Max. dumping clearance		11.53
f- Min. dumping clearance		2.08
g- Max. vertical wall digging depth		11.19
h- Min. swing radius		4.73
i- Horizontal digging stroke at ground level		11.61
j- Digging depth for 2.4 m (8') flat bottom		11.91
Bucket capacity ISO heaped	m ³	0.45

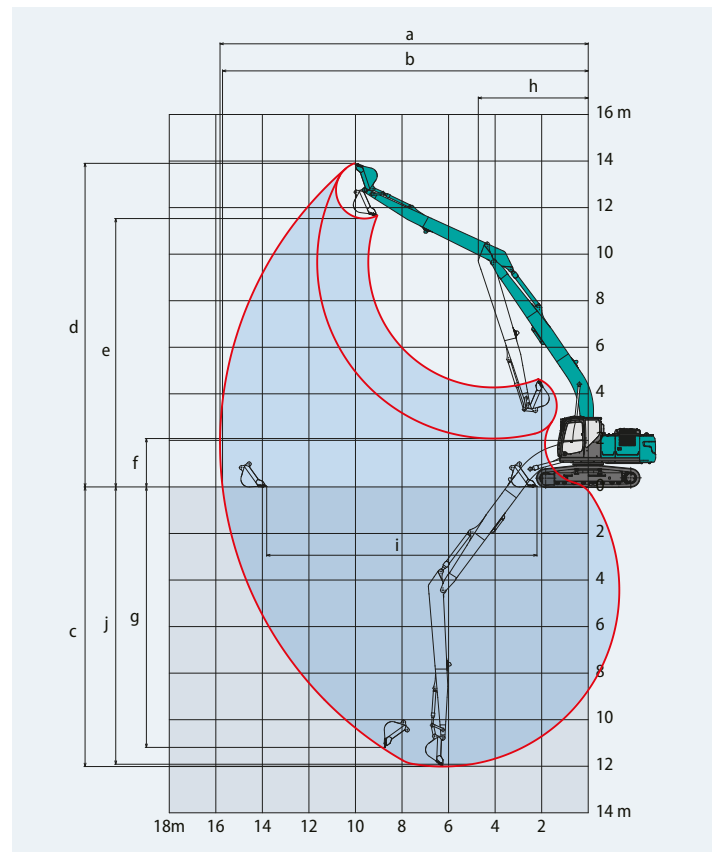

Lift capacities

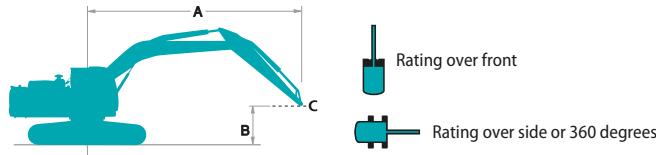

A - Reach from swing centerline to arm top
 B - Arm top height above/below ground
 C - Lift point
 Bucket : Without bucket
 Relief valve setting: 34.3 MPa (350 kgf/cm²)

SK210LC		Boom: 8.75 m Arm: 6.35 m Bucket: without Shoe: 600 mm																					
B	A	1.5 m		3.0 m		4.5 m		6.0 m		7.5 m		9.0 m		10.5 m		12.0 m		13.5 m		At max. reach		Radius	
		Rating over front	Rating over side or 360 degrees	Rating over front	Rating over side or 360 degrees	Rating over front	Rating over side or 360 degrees	Rating over front	Rating over side or 360 degrees	Rating over front	Rating over side or 360 degrees	Rating over front	Rating over side or 360 degrees	Rating over front	Rating over side or 360 degrees	Rating over front	Rating over side or 360 degrees	Rating over front	Rating over side or 360 degrees	Rating over front	Rating over side or 360 degrees		
12.0 m	kg																				*1,080	*1,080	10.44 m
10.5 m	kg														*1,880	*1,880					*1,000	*1,000	11.72 m
9.0 m	kg														*2,220	*2,220	*1,620	*1,620			*950	*950	12.70 m
7.5 m	kg														*2,430	*2,430	*2,070	*2,070			*930	*930	13.44 m
6.0 m	kg														*2,560	*2,560	*2,400	2,060	*1,510	*1,510	*930	*930	13.98 m
4.5 m	kg												*3,020	*3,020	*2,740	2,520	*2,550	1,980	*1,900	1,560	*940	*940	14.35 m
3.0 m	kg			*5,190	*5,190	*6,520	*6,520	*4,810	*4,810	*3,890	*3,890	*3,330	3,050	*2,950	2,380	*2,680	1,880	*2,190	1,500	*970	*970	14.54 m	
1.5 m	kg					*7,340	7,280	*5,600	4,990	*4,380	3,680	*3,640	2,830	*3,160	2,230	*2,810	1,780	2,350	1,440	*1,020	*1,020	14.58 m	
G.L.	kg			*2,060	*2,060	*4,980	*4,980	*6,190	4,520	*4,780	3,380	*3,910	2,630	*3,340	2,090	2,760	1,690	2,300	1,380	*1,090	*1,090	14.47 m	
-1.5 m	kg	*2,040	*2,040	*2,810	*2,810	*4,960	*4,960	*6,520	4,230	*5,050	3,160	4,040	*2,470	3,250	1,990	2,680	1,620	2,250	1,340	*1,180	*1,180	14.19 m	
-3.0 m	kg	*2,940	*2,940	*3,720	*3,720	*5,610	*5,610	*6,610	4,090	5,070	3,030	3,930	2,370	3,170	1,910	2,630	1,570	*1,860	1,320	*1,320	1,290	13.75 m	
-4.5 m	kg	*3,880	*3,880	*4,740	*4,740	*6,630	6,140	*6,480	4,040	5,010	2,970	3,880	2,320	3,140	1,880	2,620	1,560				*1,510	1,380	13.11 m
-6.0 m	kg	*4,890	*4,890	*5,910	*5,910	*7,960	6,250	*6,120	4,080	*4,890	2,980	3,880	2,320	3,150	1,890	*2,580	1,590				*1,800	1,550	12.26 m
-7.5 m	kg	*6,030	*6,030	*7,300	*7,300	*7,040	6,440	*5,510	4,190	*4,440	3,050	*3,620	2,380	*2,900	1,950						*2,290	1,820	11.15 m
-9.0 m	kg			*7,450	*7,450	*5,700	*5,700	*4,550	4,380	*3,660	3,200	*2,860	2,520								*2,470	2,310	9.67 m
-10.5 m	kg					*3,700	*3,700	*2,980	*2,980	*2,190	*2,190										*2,110	*2,110	7.62 m

Notes:

- Do not attempt to lift or hold any load that is greater than these lift capacities at their specified lift point radius and heights. Weight of all accessories must be deducted from the above lift capacities.
- Lift capacities are based on machine standing on level, firm, and uniform ground. User must make allowance for job conditions such as soft or uneven ground, out of level conditions, side loads, sudden stopping of loads, hazardous conditions, experience of personnel, etc.
- Arm top defined as lift point.
- The above lift capacities are in compliance with ISO 10567. They do not exceed 87% of hydraulic lift

- capacity or 75% of tipping load. Lift capacities marked with an asterisk (*) are limited by hydraulic capacity rather than tipping load.
- Operator should be fully acquainted with the Operator's and Maintenance Instructions before operating this machine. Rules for safe operation of equipment should be adhered to at all times.
- Lift capacities apply to only machine as originally manufactured and normally equipped by KOBELCO CONSTRUCTION MACHINERY CO., LTD.

Standard and Optional Equipment

● = Std ○ = Opt — = N/A

Category	Description	SK210(N)LC-11		
		Mono Boom / 2 Piece Boom		Long Reach
		LC	NLC	LC
Engine	Hino J05EVA-KSSA (EU Stage V compliant)		●	
	Exhaust DOC DPF SCR system		●	
	Alternator 24 V/ 60 A		●	
	Starter motor 24 V/ 5 kW		●	
	Batteries 2 x 112Ah		●	
	Fan suction type cooling system		●	
	Auto deceleration function		●	
	Auto idle stop (AIS)		●	
Hydraulic system	3 work modes H, S, Eco		●	
	Power boost (37.8 MPa (385 kgf/cm ²))	●		—
	Heavy lift mode	●		—
	Pressure release function		●	
	Independent travel function		●	
	Auto warm up system		●	
	Proportional Hand Control (for E&N&B piping)	●		—
	Proportional Hand Control (for Extra piping)	—		●
	Hydraulic oil VG32		●	
	Hydraulic oil VG46		○	
Hydraulic oil VG68		○		
Piping	E & N&B piping		●	—
	E & N&B piping + Bigger capacity P4 pump (89.4 L/min)		○	—
	Standard piping (only mono boom spec)	○		—
	Extra piping		—	●
Cabin	QH piping		●	
	Air suspension seat with heating		●	
	10 inch colour monitor		●	
	LED door light		●	
	Air-conditioner		●	
	DAB + radio (FM/AM & AUX & USB & Bluetooth* & hands free telephone)		●	
	Harness for CAB four lights and CAB yellow flasher		●	
	Parallel wiper		●	
	12 V power supply		●	
	Rain visor		○	
Lights	Sun screen		○	
	LED work lights ; 2 on boom & 1 on upper frame		●	
Working equipment	LED work lights ; 2 on Cab top front		○	
	Standard Boom (5.65 m)		●	—
	2 Piece Boom		○	—
	Long Reach Boom (8.75 m)		—	●
	Standard HD arm (2.94 m) with rock guard		●	—
	Short HD arm (2.40 m) with rock guard		○	—
	Long HD arm (3.50 m) with rock guard		○	—
	Long Reach arm (6.35 m)		—	●
Counterweight	OHK hook		●	—
	Standard C/W (TTL 4,300 kg)		●	—
	Semi heavier C/W (TTL 4,900 kg)		○	—
Undercarriage	Heavier C/W (TTL 5,490 kg)		—	●
	600 mm steel shoe		●	
	700 mm steel shoe		○	
	790 mm steel shoe		○	
	900 mm steel shoe	○		○
	Track guide (one per side)		●	
Safety	Additional track guides (two additional per side)		○	
	Lower frame guard		●	
	Engine emergency stop switch		●	
	Pump emergency mode (KPSS release switch)		●	
	Emergency accel dial		●	
	Emergency manual valve for lowering attachment		●	
	Overload alarm		●	
	Safety valve for boom & arm cylinder		●	
	ROPS compliant cab (ISO 12117-2:2008)		●	
	OPG Level II top guard (ISO 10262:1998)		●	
	OPG Level II front guard (ISO 10262:1998)		○	
	Eagle-eye view camera (Rear, Right, Left)		●	
	Seatbelt indicator on display		●	
	Travel alarm		○	
Extended guard rail		○		
Others	Refueling pump		●	
	Harness for engine room light		●	
	Ral color		○	
	KOMEXS		●	

*The air conditioning system on this machine contains fluorinated greenhouse gas HFC-134a (GWP 1430). Quantity of gas 0.9 kg (CO₂ equivalent 1.3 t).
Note: Bluetooth* is a registered trademark of the Bluetooth SIG Inc.

Note: This catalogue may contain attachments and optional equipment that are not available in your area. And it may contain photographs of machines with specifications that differ from those of machines sold in your areas. Please consult your nearest KOBELCO distributor for those items you require.
Specialist equipment is needed to use this machine in demolition work. Before using it please contact your KOBELCO dealer.
Due to our policy of continuous product improvements all designs and specifications are subject to change without advance notice.
Copyright by **KOBELCO CONSTRUCTION MACHINERY CO., LTD.** No part of this catalogue may be reproduced in any manner without notice.

KOBELCO CONSTRUCTION MACHINERY EUROPE B.V.

Veluwezoom 15
1327 AE Almere
The Netherlands
www.kobelco-europe.com

Enquiries To: