

# CM 74S4

# serie performance

## Gru idraulica a montaggio rapido

Hydraulic crane with quick assembling  
Grue hydraulique à montage rapide  
Hydraulischer Schnellmontagekran  
Grúa hidráulica de montaje rápido

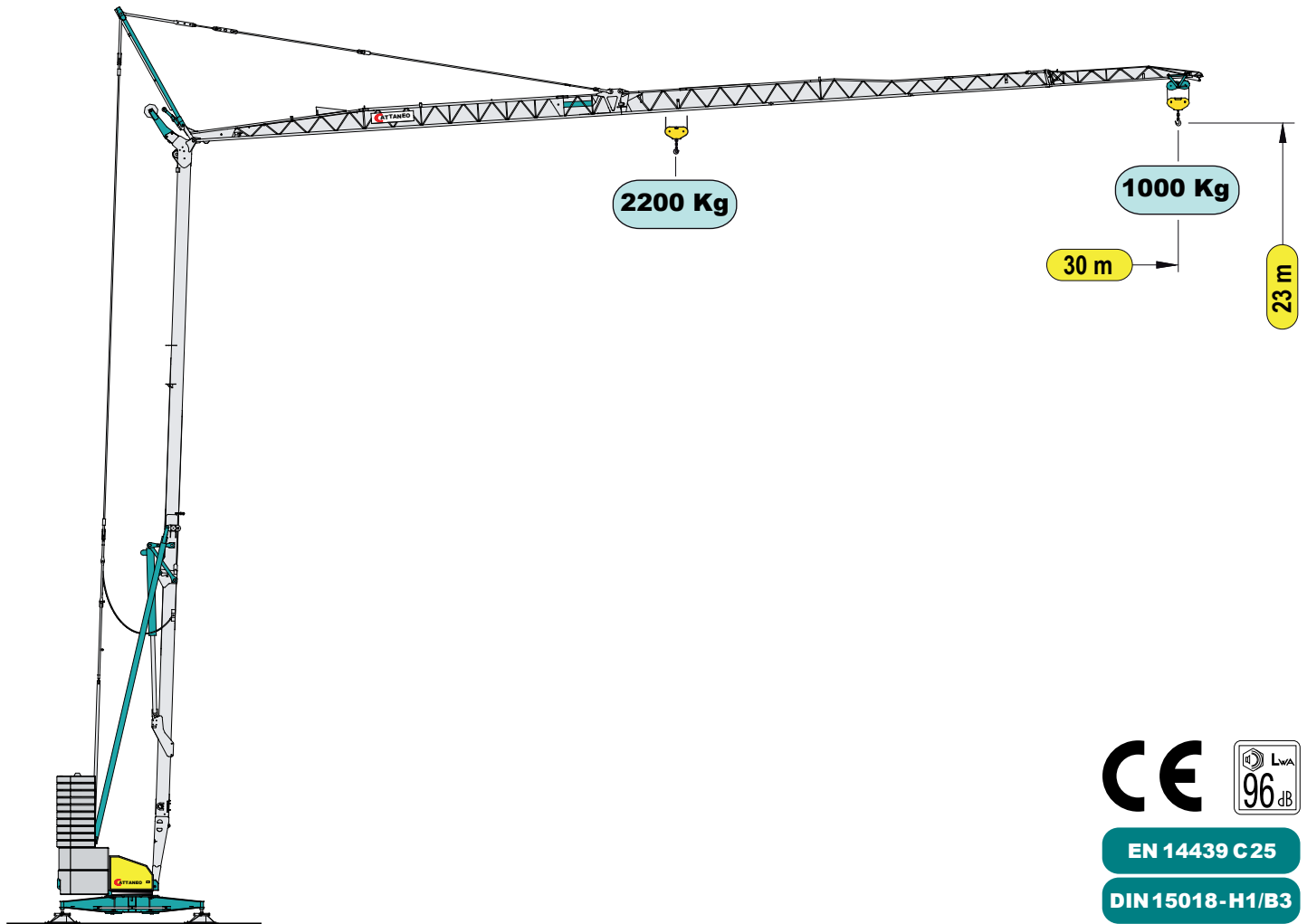

EN 14439 C25

DIN 15018-H1/B3













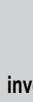

**PROGETTO:** Ufficio Tecnico LUIGI CATTANEO SpA  
**COSTRUZIONE:** Stabilimenti LUIGI CATTANEO SpA

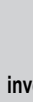
# CATTANEO

Luigi Cattaneo S.p.A.  
via Trieste 14 - 20020 Magnago (MI) Italia  
tel. +39 331 657132 - fax +39 331 305460  
www.cattaneogrui.it



## Prestazioni - Performances - Prestations - Leistungen - Prestaciones

	 <b>kVA</b>	 <b>400V - 50Hz 12 kVA</b>										
			 <b>inverter</b>	<b>kW/g/min</b> 7,5/1400		1°	2°	3°	4°			
	 <b>inverter</b>					<b>kW/g/min</b> 7,5/1400		m/min	5	21	32	45
								kg	2.200	2.200	1000	1000
	 <b>inverter</b>	<b>3/1400</b>		m/min	25 - 50							
	 <b>inverter</b>	<b>2,2/1400</b>		g/min	0,4 - 0,9							

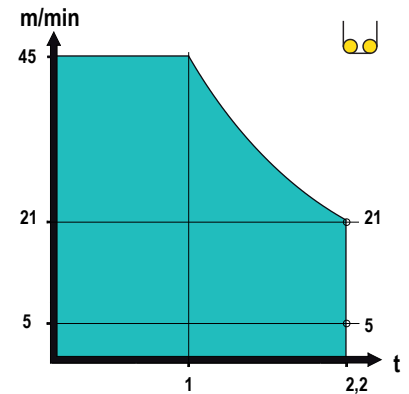

## Contrappeso in lastre di cemento armato - Ferro-concrete ballast slabs Contrepoids en plaques de béton armé - Gegengewicht aus Betonplatten - Lastre en hormigón armado

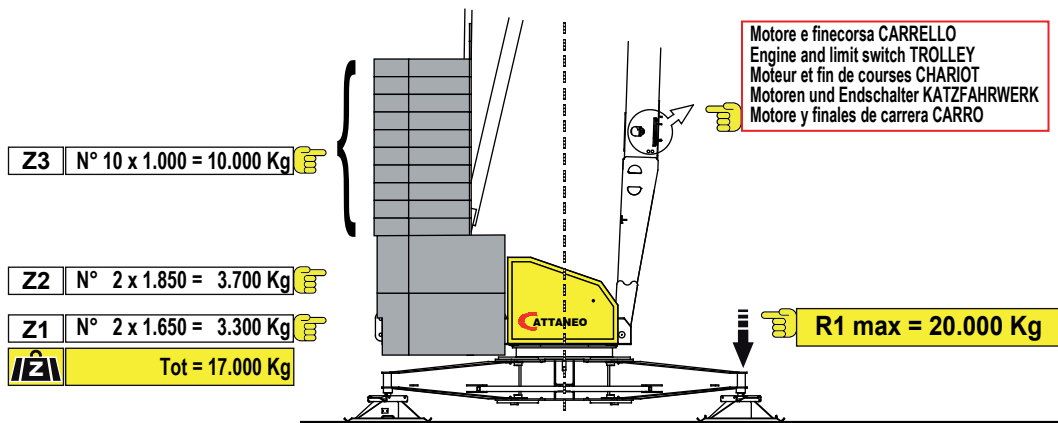

## Trasporto - Transport - Transport - Transport - Transporte

